

**KMEW**

# SIDING

DECORATIVE  
WALL PANEL



**SCG**

*For Thailand Only*

# CORPORATE OVERVIEW

*As the only company in Japan that specializes in exteriors, KMEW offers complete solutions including products such as roofing tiles, siding panels and rain gutters.*

Since our inception, KMEW has bend Make Homes Attractive. We have not restricted these activities to Japan alone, and have expanded to service overseas markets as well.

KMEW building materials had considerable success as high-quality products bearing the label of a Japanese brand. Moving forward, we aim to gain more understanding of living and construction activities in various countries all over the world, and use the knowledge and technical skills gained in all countries to contribute to the development of a global housing culture.



## COMPANY DATA

Capital 8 billion yen

Number of employees 1,978 (1 Apr 2019)

- |   |  |
|---|--|
| <ul style="list-style-type: none"> <li>1890 ◆ Opened Oide Chuzo-jo (Oide Foundry)</li> <li>1918 ▲ Opened Matsushita Electric Housewares Manufacturing Works</li> <li>1945 ▲ Changed the company name to Matsushita Electric Works, Ltd.</li> <li>1957 ◆ Advanced into the arena of housing-related materials.</li> <li>1958 ▲ Launched plastic rain gutter</li> <li>1961 ◆ Launched roofing tiles "COLORBEST COLONIAL"</li> </ul> | <ul style="list-style-type: none"> <li>1971 ▲ Started roofing business, launched "FullBest16"</li> <li>1980 ▲ Launched siding panel "Multi Siding"</li> <li>1981 ◆ Launched fireproof siding (horizontal joint)</li> <li>1985 ◆ Launched serve-press siding panel material "Ceracity"</li> <li>1987 ◆ Launched siding panel "CeraDeal18"</li> <li>1987 ▲ Launched siding panel "Neo Rock"</li> </ul> |
|---|--|

# ORGANIZATIONAL STRUCTURE

Two Japanese companies with high-tech capabilities and established track records combined their top-class expertise in exterior building materials to create KMEW.



In 2003, Kubota Corporation and Matsushita Electric Works (now Panasonic) merged their respective divisions specializing in exterior products for residences and created Kubota Matsushitadenko Exterior Works Ltd. The name spread across the world with a reputation for high-quality exterior products.

## OUR MISSION

*KMEW, the leading exterior product manufacturer in Japan, is determined to make greater contribution to the development of better housing culture all over the world through premium quality products.*

People around the world trust in “Made-in-Japan.” We at KMEW not only respond to this trust, but offer “Experience Beyond Expectation” with our products. For this purpose, we set up our own strict standards named KMEW Premium Quality, and deliver the best possible products to various countries throughout the world, in accordance with our motto.



- MILESTONES
- ◆ Kubota Corporation

- ▲ Matsushita Electric Works, Ltd. (now Panasonic)
- KMEW Co., Ltd.

- 1990 ◆ Changed the company name to Kubota Corporation
- 1997 ▲ Launched metal siding “Haru Ichiban”
- 1999 ▲ Launched siding panel “Ceramic coating Series”
- 2002 ▲ Launched siding panel “Hikari Cera Series” Founded as the Matsushitadenko Exterior Works Co., Ltd.
- 2002 ◆ Launched COLORBEST “GLASSA Series”
- 2003 ● Kubota Matsushitadenko Exterior Works Co., Ltd.

- 2007 ● Launched siding panel “Hikari Cera Pixcera”  
Launched roofing tiles “ROOGA”
- 2009 ● Launched siding panel “Shinsui Cera”
- 2010 ● Changed the company name to KMEW Co., Ltd.
- 2011 ● Launched ColorBest “Shanetsu GLASSA”
- 2012 ● Launched siding panel “Ceratopia”
- 2019 ● **KMEW Co., Ltd. Cooperate with SCG to distribute Siding product in THAILAND**

# OUR PANEL JOINT SYSTEM

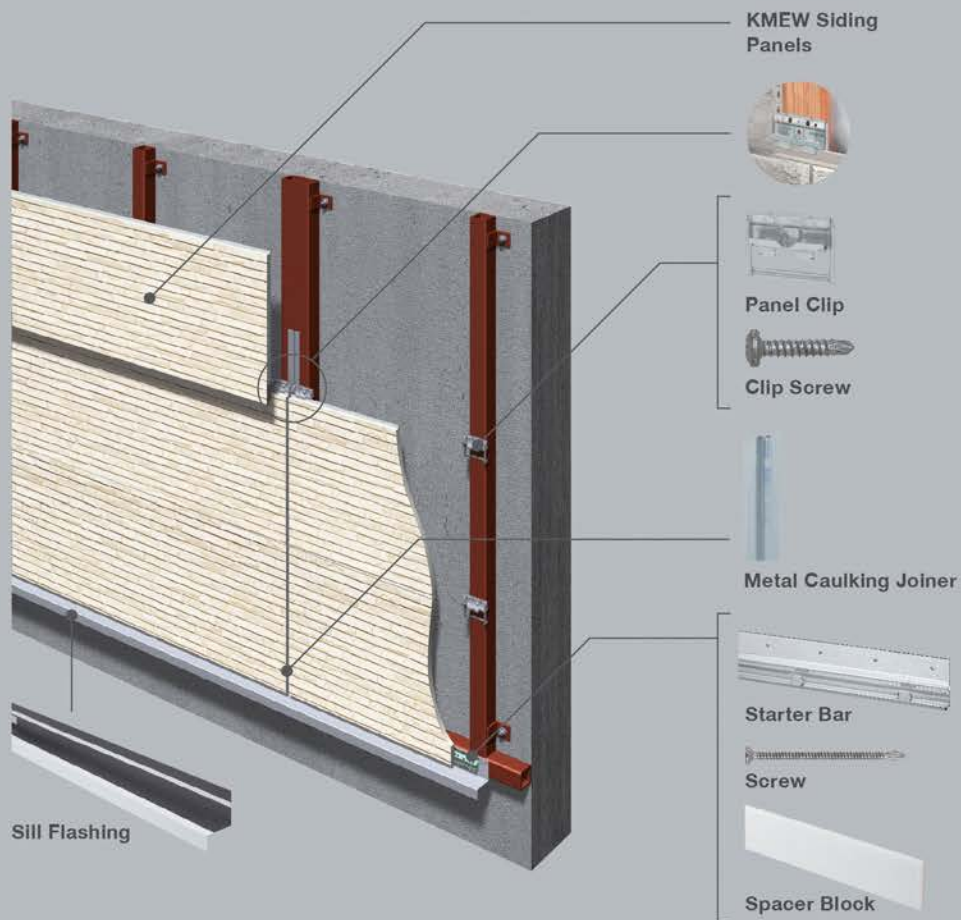

## PANEL JOINT SYSTEM

*Creates a seamless panelized appearance*

Suitable for residential and commercial buildings, the KMEW Siding consists of pre-finished siding panels and innovative mounting clips and accessories, all of which have been designed for ease of installation.

# AND RAIN SCREEN SYSTEM

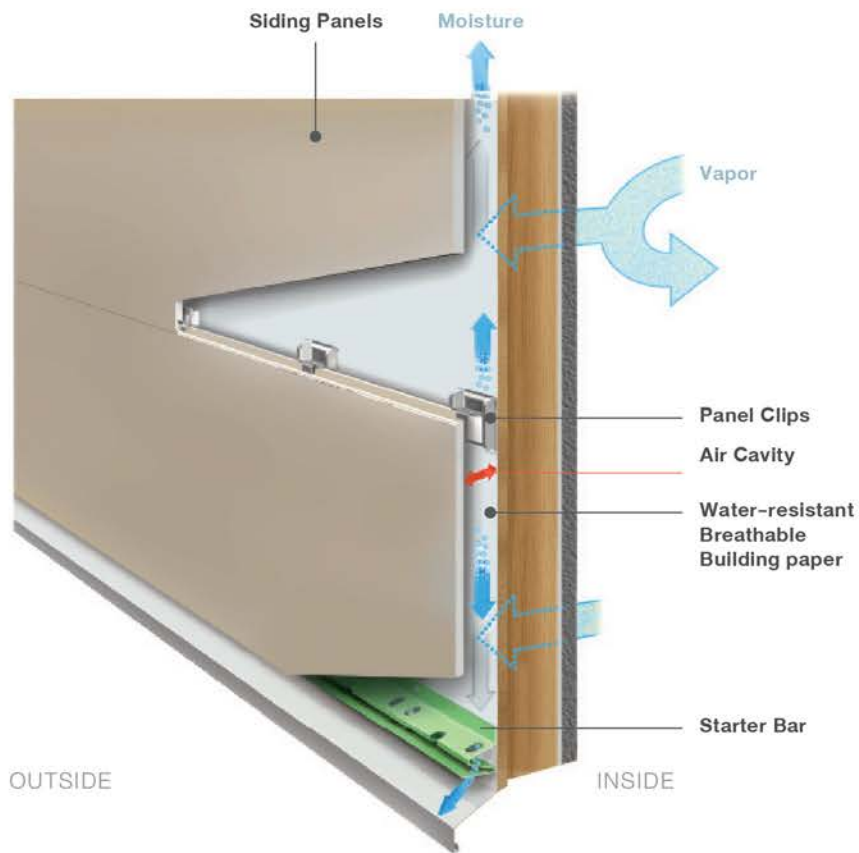

## RAIN SCREEN SYSTEM

*Creates a ventilation layer to keep moisture out*

The KMEW Rain Screen Exterior Siding System helps avoid mold and health problems and dry-rot in walls. A "Ventilation layer", that is, an air passage created in wall cavities prevents dew condensation in the cavities by quickly releasing humid indoor air that permeates through inner walls and gaps between members to the outside.

# DECOMPOSITION POWER

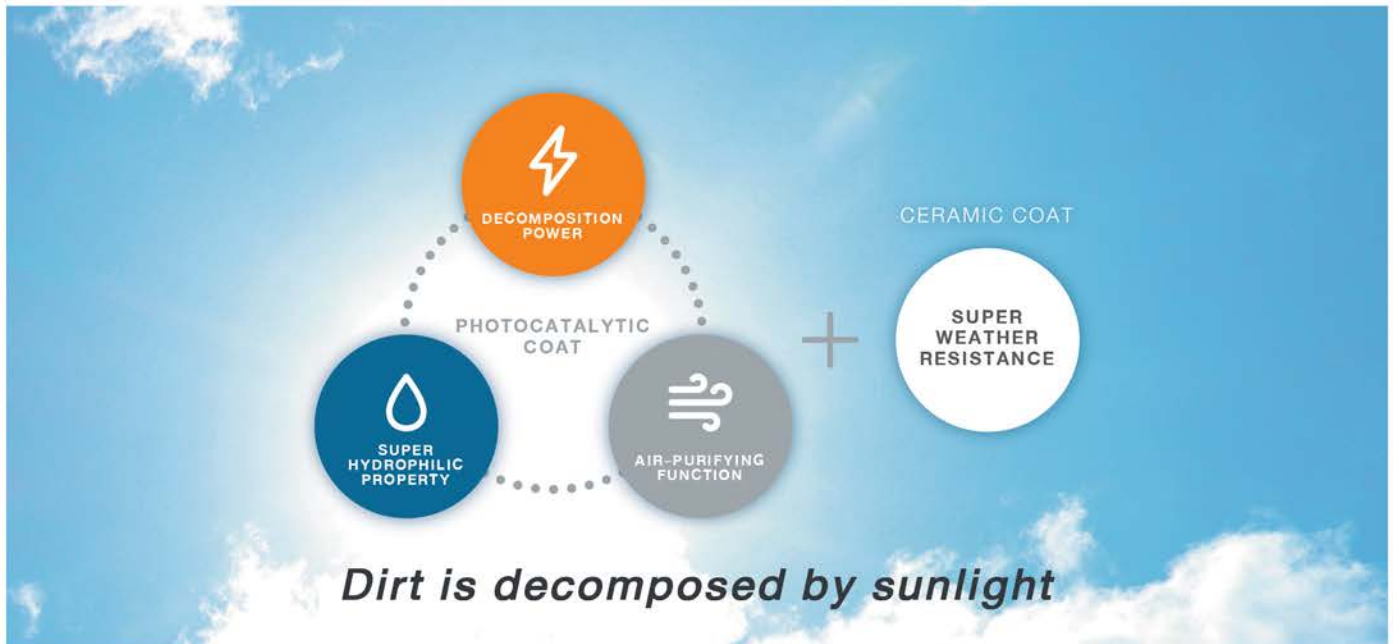

*Dirt is decomposed by the sun (Ultraviolet Rays), weakening adhesion.*

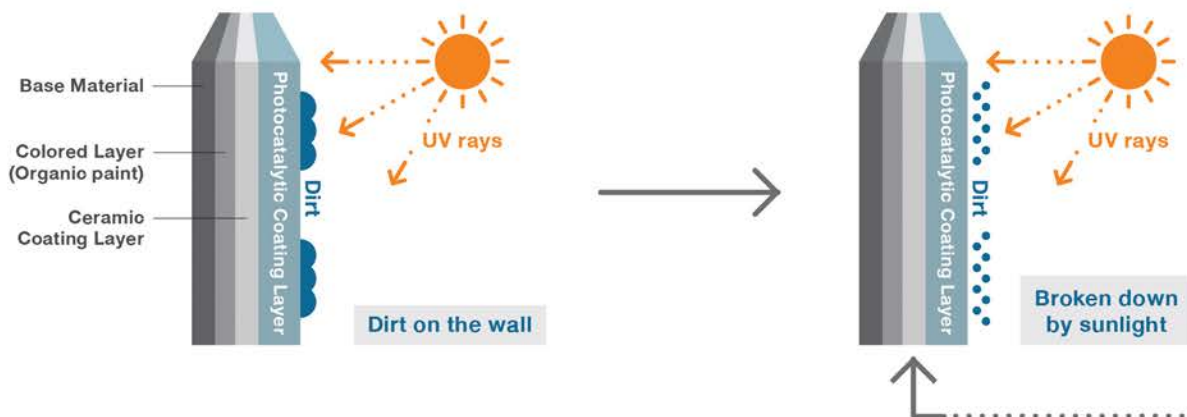

*Dirt is decomposed by sunlight*

Oil-based contaminants, which can lead to dirt and black spots, and other molecules are decomposed and their adhesion weakened.

- Accelerated decomposition test (in-house experimentation results)  
 [Test condition] Dirt: Methylene blue dye / Sterilizing lamp used as ultraviolet lamp

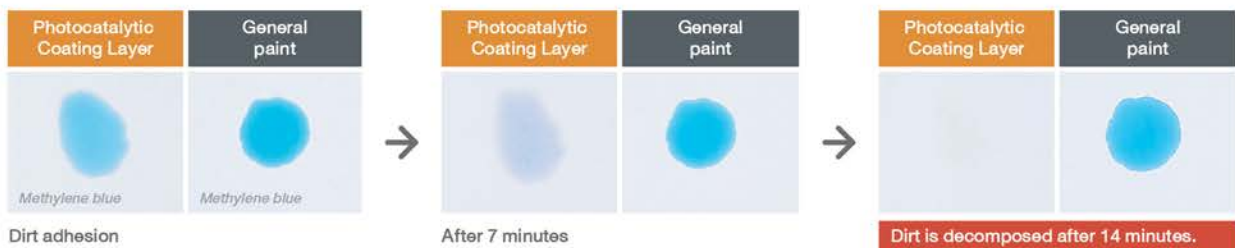

# SUPER HYDROPHILIC PROPERTY



*Due to the extreme compatibility with water, rainwater rinses off dirt.*

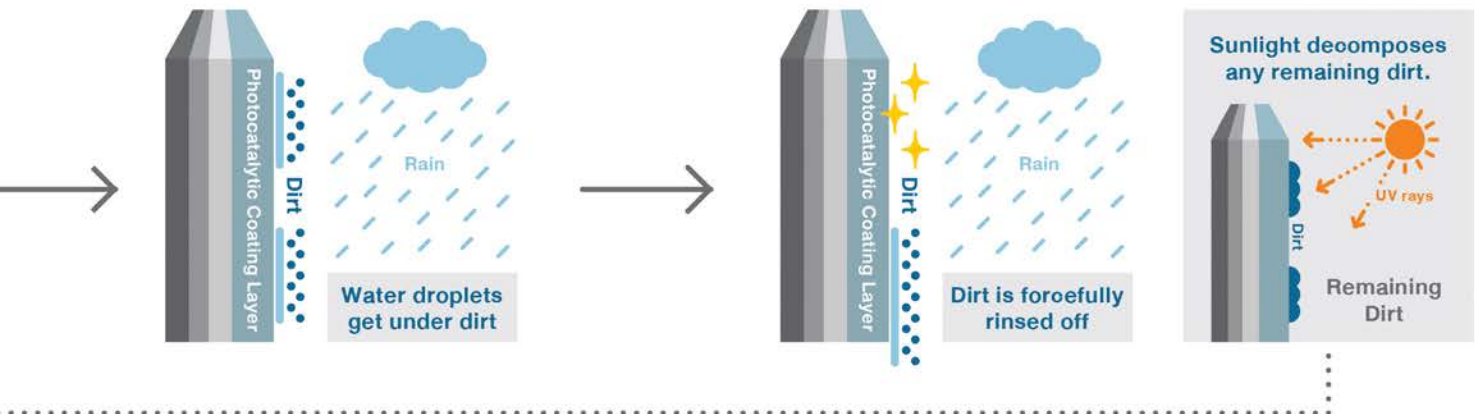

## *Compatibility with water allows for easy cleaning*

The extremely high hydrophilic properties of the photocatalytic coating layer provide a beneficial relationship with water. (Super hydrophilic property)  
Dirt comes to the surface and runs down together with rain.

Photocatalytic Coating Layer	Hydrophilic Coating	General siding materials
<ul style="list-style-type: none"> <li>Dirt removal test (in-house experimentation results) [Test Conditions] Dirt: Soil + oleic acid</li> </ul>		
<ul style="list-style-type: none"> <li>High compatibility with water (Illustrative image)</li> </ul>		
High hydrophilicity	Low hydrophilicity	
High compatibility with water		

# PHOTOCATALYTIC CERAMIC COATING

*is especially recommended for white siding.  
Dirt is hardly noticeable even after 6 or 7 years.*



When newly built



7 years after building



When newly built



7 years after building



## GENERAL COATING (ORGANIC PAINT)

*The picture shows a building constructed about 10 years age and coated with organic enamel paint.*



Raindrops cause brown dirt to stick under the window sash.



# SUPER WEATHER RESISTANCE

*The high resistance to UV rays minimizes degradation and color fading*

The weather resistant, UV-cutting ceramic coating (inorganic coating) maintains the beautiful colors for many years as they were when the panels were installed in a newly built house or building.

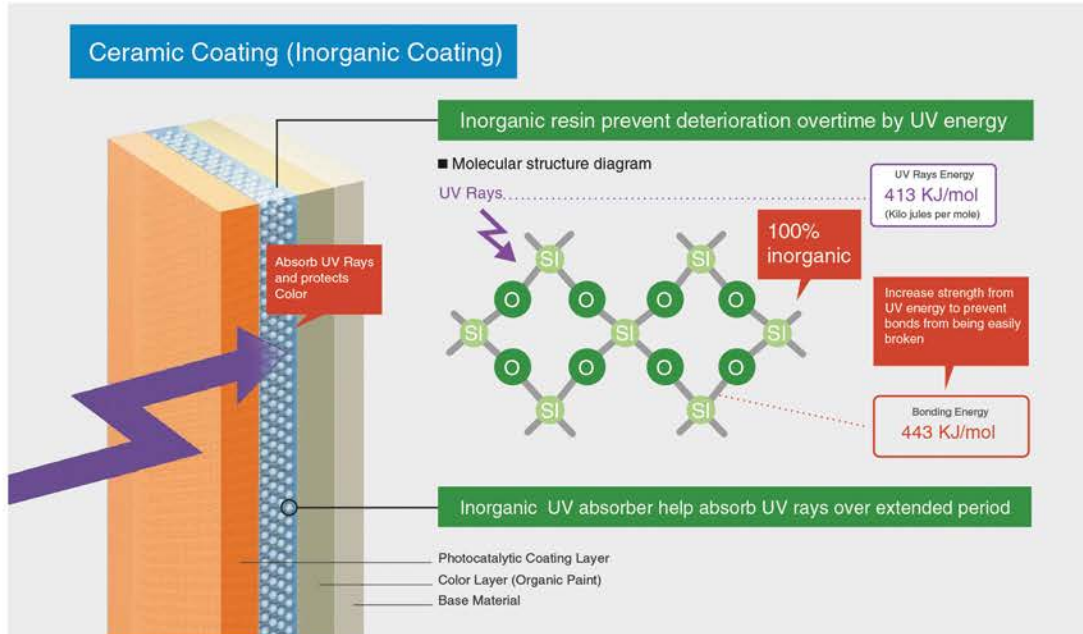

With Photocatalytic ceramic coating, color-fading and sunburning are almost unnoticeable even after 10 years, which ensures the building's original beauty is maintained.



## GENERAL COATING (ORGANIC PAINT)

*The picture shows a building constructed about 10 years ago and coated with organic enamel paint.*



**AH5391U****AH5392U****AH5393U****AH5394U**

\*สินค้าพร้อมจำหน่าย

Product code	Thickness (mm.)	Width (mm.)	Length (mm.)	Weight (kg.)
AH5391U	21	455	3030	24
AH5392U	21	455	3030	24
AH5393U	21	455	3030	24
AH5394U	21	455	3030	24



**AH5351U**



**AH5352U**



**AH5353U**



**AH5354U**

\*สินค้าสั่งผลิต ระยะเวลา 30-45 วัน

Product code	Thickness (mm.)	Width (mm.)	Length (mm.)	Weight (kg.)
AH5351U	21	455	3030	24
AH5352U	21	455	3030	24
AH5353U	21	455	3030	24
AH5354U	21	455	3030	24

**AH5361U****AH5362U****AH5363U****AH5364U**

\*สินค้าสั่งผลิต ระยะเวลา 30-45 วัน

Product code	Thickness (mm.)	Width (mm.)	Length (mm.)	Weight (kg.)
AH5361U	21	455	3030	24
AH5362U	21	455	3030	24
AH5363U	21	455	3030	24
AH5364U	21	455	3030	24



**AH5371**



**AH5372**



**AH5373**



**AH5374**

\*สินค้าสั่งผลิต ระยะเวลา 30-45 วัน

Product code	Thickness (mm.)	Width (mm.)	Length (mm.)	Weight (kg.)
AH5371	21	455	3030	25
AH5372	21	455	3030	25
AH5373	21	455	3030	25
AH5374	21	455	3030	25

**AH5381****AH5382****AH5383****AH5384**

\*สินค้าสั่งผลิต ระยะเวลา 30-45 วัน

Product code	Thickness (mm.)	Width (mm.)	Length (mm.)	Weight (kg.)
AH5381	21	455	3030	25
AH5382	21	455	3030	25
AH5383	21	455	3030	25
AH5384	21	455	3030	25



**AH5411**



**AH5412**



**AH5413**



**AH5414**



**AH5415**

\*สินค้าสั่งผลิต ระยะเวลา 30-45 วัน

Product code	Thickness (mm.)	Width (mm.)	Length (mm.)	Weight (kg.)
AH5411	21	455	3030	25
AH5412	21	455	3030	25
AH5413	21	455	3030	25
AH5414	21	455	3030	25
AH5415	21	455	3030	25



NH5481U



NH5491U

\*สินค้าพร้อมจำหน่าย

Product code	Thickness (mm.)	Width (mm.)	Length (mm.)	Weight (kg.)
NH5481U	18	455	3030	25
NH5491U	18	455	3030	25





**NH5642A**



**NH5643A**



**NH4801A**



**NH4802A**



**NH4803A**

\*สินค้าสั่งผลิต ระยะเวลา 30-45 วัน

Product code	Thickness (mm.)	Width (mm.)	Length (mm.)	Weight (kg.)
NH5642A	18	455	3030	21
NH5643A	18	455	3030	21
NH4801A	16	455	3030	21
NH4802A	16	455	3030	21
NH4803A	16	455	3030	21



*FH4911U*



*FH4912U*



*FH4913U*



*FH4914U*

\*สินค้าสั่งผลิต ระยะเวลา 30-45 วัน

Product code	Thickness (mm.)	Width (mm.)	Length (mm.)	Weight (kg.)
FH4911U	16	455	3030	25
FH4912U	16	455	3030	25
FH4913U	16	455	3030	25
FH4914U	16	455	3030	25



**FH4851U**



**FH4853U**



**FH4854U**

\*สินค้าสั่งผลิต ระยะเวลา 30-45 วัน

Product code	Thickness (mm.)	Width (mm.)	Length (mm.)	Weight (kg.)
FH4851U	16	455	3030	24
FH4853U	16	455	3030	24
FH4854U	16	455	3030	24



**NH4971A**



**NH4972A**



**NH4973A**



**NH4974A**



**NH4975A**



**NH4976A**

**\*สินค้าพร้อมจำหน่าย**

Product code	Thickness (mm.)	Width (mm.)	Length (mm.)	Weight (kg.)
NH4971A	16	455	3030	20
NH4972A	16	455	3030	20
NH4973A	16	455	3030	20
NH4974A	16	455	3030	20
NH4975A	16	455	3030	20
NH4976A	16	455	3030	20

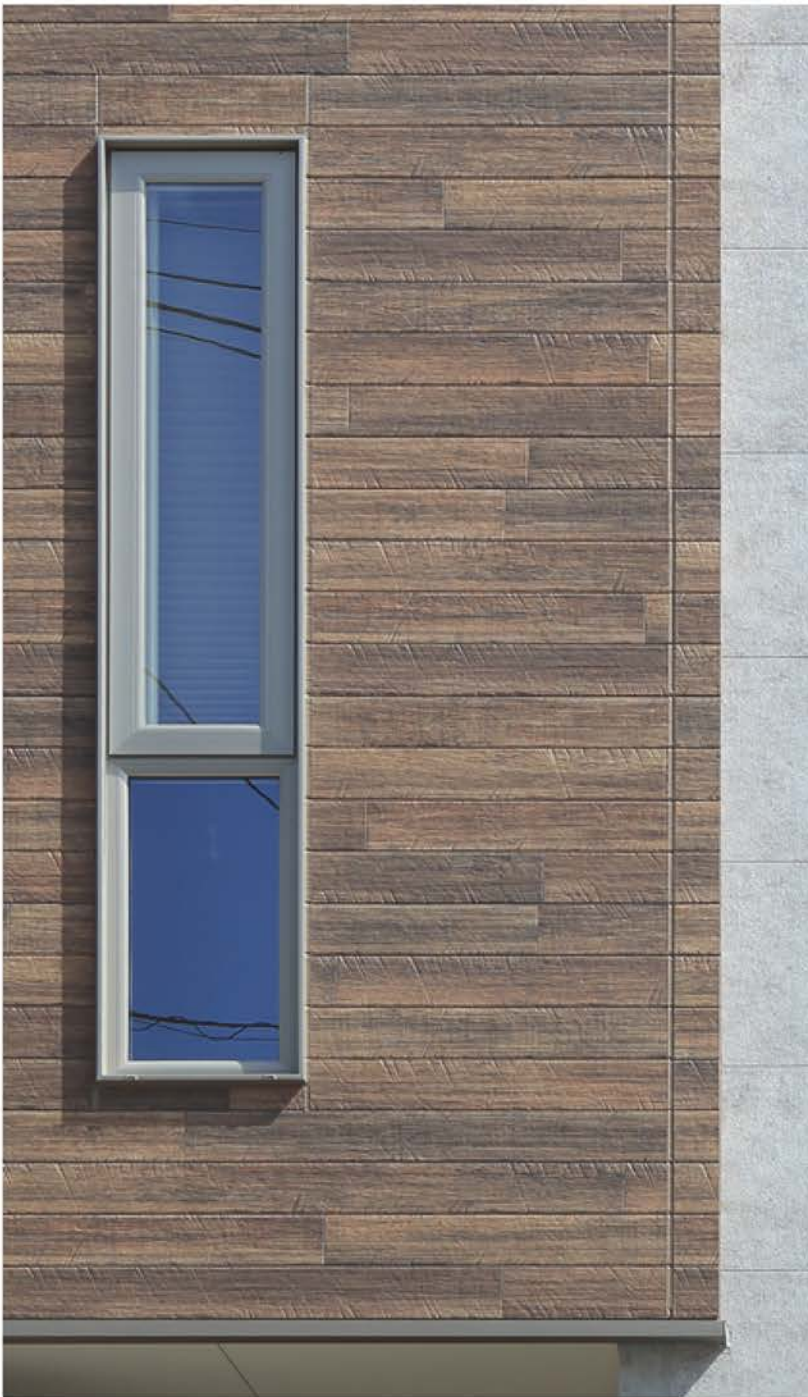

**NH4977A**



**NH4978A**



**NH4979A**



**NH49710A**

\*สินค้าสั่งผลิต ระยะเวลา 30-45 วัน

Product code	Thickness (mm.)	Width (mm.)	Length (mm.)	Weight (kg.)
NH4977A	16	455	3030	20
NH4978A	16	455	3030	20
NH4979A	16	455	3030	20
NH49710A	16	455	3030	20

**NH5689A****NH5687A****NH5685A****NH5686A**

\*สินค้าสั่งผลิต ระยะเวลา 30-45 วัน

Product code	Thickness (mm.)	Width (mm.)	Length (mm.)	Weight (kg.)
NH5689A	18	455	3030	20
NH5687A	18	455	3030	20
NH5685A	18	455	3030	20
NH5686A	18	455	3030	20



**NH5531U**



**NH5532U**



**NH5533U**



**NH5534U**

\*สินค้าสั่งผลิต ระยะเวลา 30-45 วัน

Product code	Thickness (mm.)	Width (mm.)	Length (mm.)	Weight (kg.)
NH5531U	18	455	3030	21
NH5532Uv	18	455	3030	21
NH5533U	18	455	3030	21
NH5534U	18	455	3030	21



NH5475U



NH5476U



NH5477U



NH5478U



NH5479U

\*สินค้าสั่งผลิต ระยะเวลา 30-45 วัน

Product code	Thickness (mm.)	Width (mm.)	Length (mm.)	Weight (kg.)
NH5475U	18	455	3030	20
NH5476U	18	455	3030	20
NH5477U	18	455	3030	20
NH5478U	18	455	3030	20
NH5479U	18	455	3030	20





NH5671A



NH5672A



NH5673A



NH5674A

\*สินค้าสั่งผลิต ระยะเวลา 30-45 วัน

Product code	Thickness (mm.)	Width (mm.)	Length (mm.)	Weight (kg.)
NH5671A	18	45	3030	20
NH5672A	18	45	3030	20
NH5673A	18	45	3030	20
NH5674A	18	45	3030	20



FH4925U



FH4926U



FH4927U



FH4928U

\*สินค้าสั่งผลิต ระยะเวลา 30-45 วัน

Product code	Thickness (mm.)	Width (mm.)	Length (mm.)	Weight (kg.)
FH4925U	16	455	3030	25
FH4926U	16	455	3030	25
FH4927U	16	455	3030	25
FH4928U	16	455	3030	25

## The individual color of each material

Iron oxide with multi-color appearance, fumes generated from refined iron, and fly ash from power plants as recycled materials mixed with the cement.

SOLIDO's look appears to be because of the materials contained in.

セメント  

---

Cement

灰 (11W)  

---

Hai



錆茶 (さびぢあ)

Sabicha

鉄黒 (てつくろ)

Tetsuguro

## The individual color of each material

Iron oxide with multi-color appearance, fumes generated from refined iron, and fly ash from power plants as recycled materials mixed with the cement.

SOLIDO's look appears to be because of the materials contained in.

セメント  
Cement

灰 (HAI)  
HAI

**FIERTTE**

STONE

WOOD





































***Kmew***

**BRICK**

ACCESSORIES

# Exterior

## STONE

			
AH5391U	AH5392U	AH5393U	AH5394U
			
AH5351U	AH5352U	AH5353U	AH5354U
			
AH5361U	AH5362U	AH5363U	AH5364U
			
AH5371	AH5372	AH5373	AH5374
			
AH5381	AH5382	AH5383	AH5384
			
AH5411	AH5412	AH5413	AH5414
			
AH5415			
			
NH5642A	NH5643A	NH4801A	NH4802A
			
NH4803A			
			
FH4911U	FH4912U	FH4913U	FH4914U
			
FH4851U	FH4853U	FH4854U	

## FIERTE

			
NH4971A	NH4972A	NH4973A	NH4974A
			
NH4975A	NH4976A		
			
NH4977A	NH4978A	NH4979A	NH49710A

## YAKISUGI

	
NH5481U	NH5491U



## WOOD



## BRICK



## ACCESSORIES

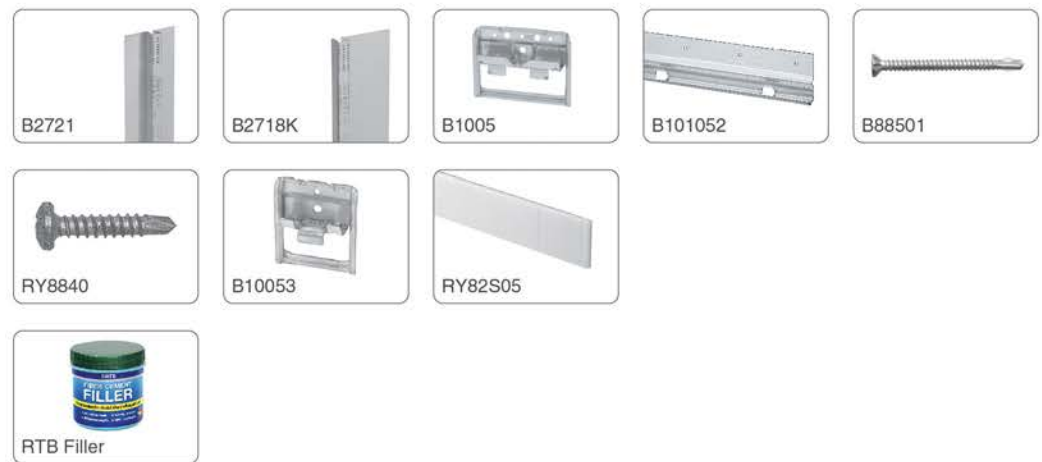

## For Exterior wall and Interior flooring

typeM\_LAP

Non-Combustible Certificate No.NM-4601  
Common name Fiber cement flat slate

Area of application	Outdoor	Indoor
Wall	OK	OK
Floor	—	—
Roof	—	—

\*สินค้าพร้อมจำหน่าย

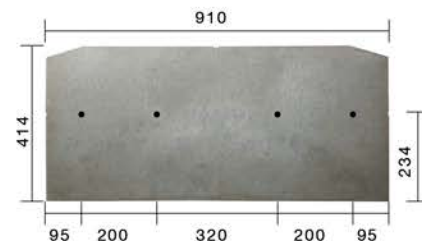

Dimensions 606 x 303 mm  
Sheets/pack 8 sheets/box  
Shipment : box unit



Weight Approximately 2kg/sheet

# ACCESSORIES FOR STEEL STUD CONSTRUCTION

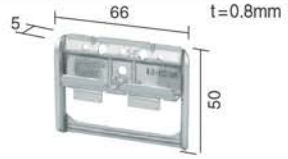
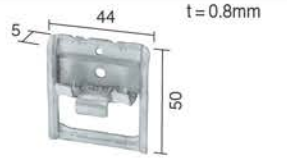

Metal accessories for horizontal application		
Product name	Panel clip	Corner clip
Member		
Item NO.	B1005	B10053
Number of packages	70 pieces / bag	50 pieces / bag
	10 bags / box	10 bags / box
	*Screws are sold separately	
Material	Hot-dip zinc-aluminium-magnesium alloy coated steel (ZAM)	

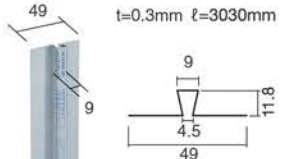
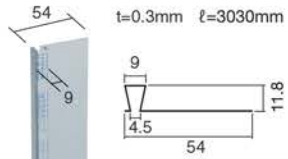
Exterior wall joint accessories		
Product name	Hat-shaped joiner	Hat-shaped joiner (one-side)
Member		
Item NO.	B2721	B2718K
Number of packages	15 pieces / box	15 pieces / box
Material	Hot-dip galvanizing-aluminium-magnesium alloy plated steel	

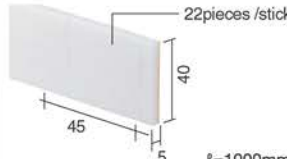
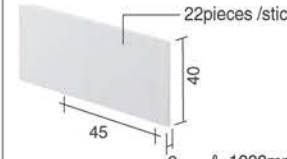
Distance adjusting materials		
Product name	Spacer5 (For opening, eave)	Spacer2 (For unevenness)
Member		
Item NO.	RY82S05	RY82S02
Number of packages	20 sticks / box	20 sticks / box
Material	Polypropylene	Polypropylene

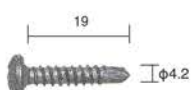
Screw			
Product name	Starter bar	Clip screw	Special screws for exterior wall panels
Member			 *Apply touch-up paint on the screw heads at site.
Item NO.	B101052	RY8840	B88501
Number of packages	4 pieces / package *Screws are sold separately	500 pieces / box	200 pieces / box
Material	Painted galvanized steel sheet	Stainless steel	Stainless steel

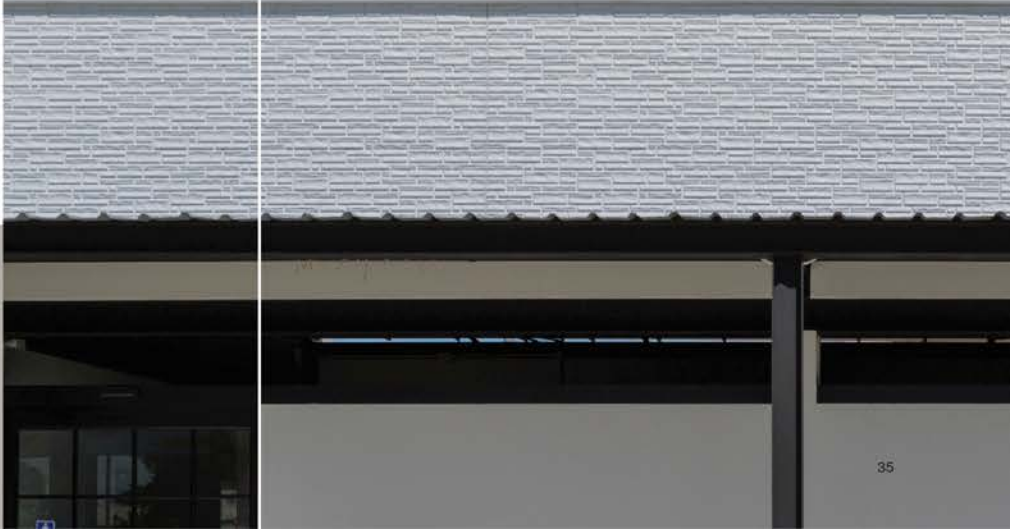
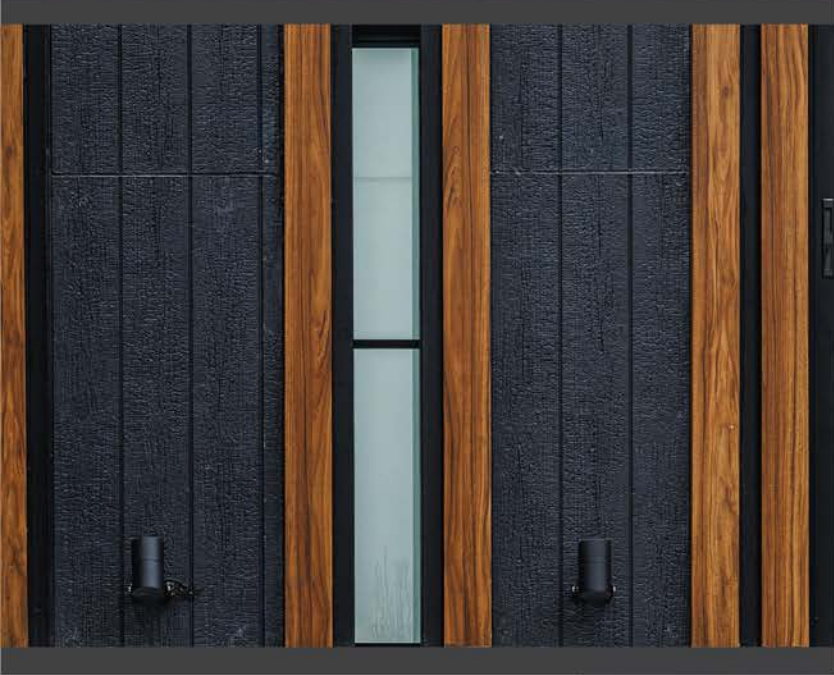
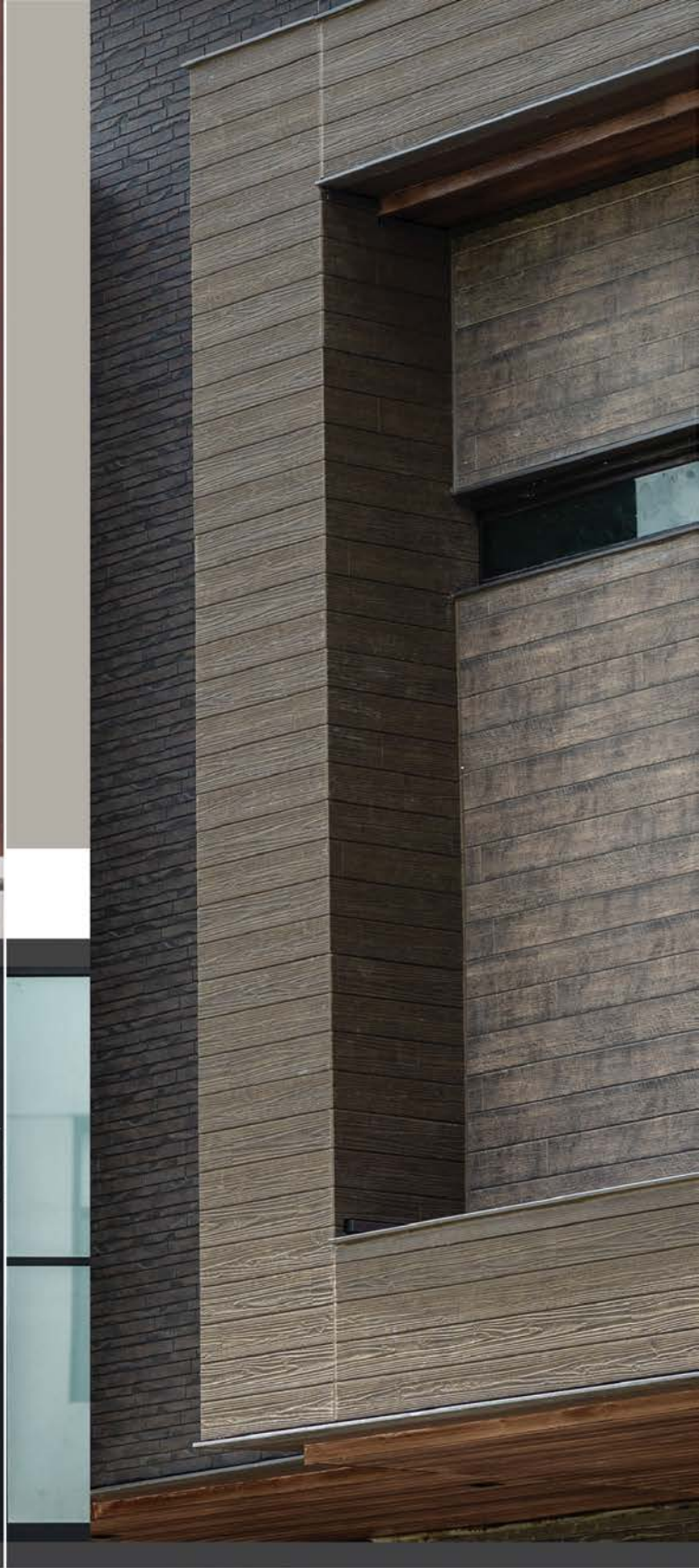



---

**Manufactured by**

KMEW CO., LTD.  
13 F CRYSTAL TOWER, 1-2-27 SHIROMI,  
CHUO-KU, OSAKA 540-6013, JAPAN

---

**Imported and distributed by**

THE SIAM FIBRE-CEMENT CO., LTD.  
1 SIAM CEMENT Rd., BANGSUE,  
BANGKOK 10800, THAILAND

**SCG Contact center : 02-586-2222**

- โปรดศึกษา "คู่มือการใช้สินค้า" และ "คู่มือการติดตั้ง" ให้เข้าใจก่อนใช้งานจริง
- รายละเอียดตามคู่มือฉบับนี้บริษัทฯ อาจเปลี่ยนแปลงได้ตามความเหมาะสมโดยไม่ต้องบอกกล่าวหรือแจ้งให้ทราบล่วงหน้า
- สีในรูปตัวอย่าง อาจแตกต่างกันเล็กน้อยเนื่องจากการพิมพ์

**KMEW**



CW-OT-D-C023/6710

**04 PRODUCT CATALOG**

- Please study "Product catalog" and "Installation manual" before use.
- The detail information in this print may be modified or updated by the company without prior notice.
- COLOR OR PRODUCTS in this print may vary slightly due to the printing process. Final color selection should be made from samples.